

SIEMENS

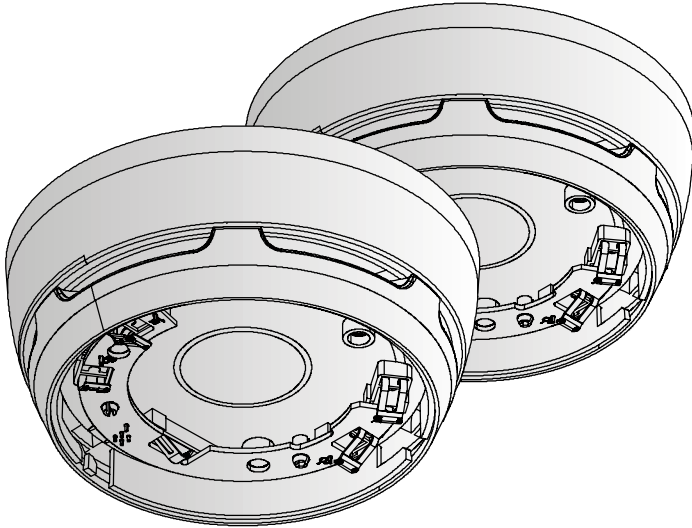

DBS721, DBS728, DBS729

**Sounder interbase,
sounder beacon interbase,
sounder interbase with
supplementary optical indication**

Technical Manual

Legal notice

Technical specifications and availability subject to change without notice.

Transmittal, reproduction, dissemination and/or editing of this document as well as utilization of its contents and communication thereof to others without express authorization are prohibited. Offenders will be held liable for payment of damages. All rights created by patent grant or registration of a utility model or design patent are reserved.

Issued by:
Siemens Switzerland Ltd.
Building Technologies Division
International Headquarters
Gubelstrasse 22
CH-6301 Zug
Tel. +41 41 724-2424
www.siemens.com/buildingtechnologies

Edition: 2016-09-21
Document ID: A6V10320094_k_en_--

© Siemens Switzerland Ltd, 2011

Table of contents

1	About this document	5
1.1	Applicable documents	7
1.2	Download center	7
1.3	Technical terms and abbreviations	7
1.4	Revision history	8
2	Safety	10
2.1	Safety instructions	10
2.2	Safety regulations for the method of operation	12
2.3	Standards and directives complied with	14
2.4	Release Notes	14
3	Structure and function	15
3.1	Overview of DBS721	15
3.2	Overview of DBS728	16
3.3	Overview of DBS729	17
3.4	Details for ordering	18
3.5	Product version ES	18
3.6	Function	19
3.6.1	Configuration	19
3.6.2	Alarm levels and sound levels	19
3.6.3	Behavior in degraded mode	21
3.6.4	Service indicator	21
3.7	Accessories	22
3.7.1	Detector base with loop contact DB721	22
3.7.2	Cover plate BP720	22
3.7.3	Interbase seal RS721	23
3.7.4	Designation plate DBZ1193A	23
3.7.5	Detector locking device LP720	23
3.7.6	Micro terminal DBZ1190-AA	24
3.7.7	Connection terminal DBZ1190-AB	24
4	Planning	25
4.1	Compatibility	25
4.2	Fields of application	25
4.3	Mounting site	26
4.4	Limitations	26
4.5	Acoustic and optical configuration	26
4.5.1	DBS721 and DBS729 acoustic signals	27
4.5.2	DBS729 optical signals	28
4.5.3	DBS728 acoustic signals	29
4.5.4	DBS728 optical signals	31
5	Mounting/Installation	32
5.1	Detector locking device LP720	34
5.2	Cover plate BP720	35

6	Commissioning	37
7	Maintenance / Repair	38
7.1	Status query	38
8	Specifications	39
8.1	Technical data DBS721	39
8.2	Technical data DBS728	41
8.3	Technical data DBS729	43
8.4	Dimensions	45
8.5	Environmental compatibility and disposal	45
9	Annex technical data	46
9.1	Tones and sound levels of the interbase	46
9.1.1	DBS721 and DBS729 tones	47
9.1.2	DBS728 tones	49
9.2	Optical beam characteristics of interbase DBS728 (DC 32 V).....	51
9.3	Optical beam characteristics of interbase DBS729 (DC 32 V).....	52
	Index	54

1 About this document

Goal and purpose

This document contains all information on the following interbase types:

- Sounder interbase DBS721
- Sounder beacon interbase DBS728
- Sounder interbase with supplementary optical indication DBS729.

Following the instructions consistently will ensure that the product can be used safely and without any problems.

Intended use

The interbases are intended to be mounted in a detector base from the 'Cerberus PRO' product line. Only point detectors from the product line 'Cerberus PRO' or the cover plate BP720 can be used in the interbases.

Do not mount an alarm sounder or other alarm devices into the interbases.

Target groups

The information in this document is intended for the following target groups:

Target group	Activity	Qualification
Product Manager	<ul style="list-style-type: none"> • Is responsible for information passing between the manufacturer and regional company. • Coordinates the flow of information between the individual groups of people involved in a project. 	<ul style="list-style-type: none"> • Has obtained suitable specialist training for the function and for the products. • Has attended the training courses for Product Managers.
Project Manager	<ul style="list-style-type: none"> • Coordinates the deployment of all persons and resources involved in the project according to schedule. • Provides the information required to run the project. 	<ul style="list-style-type: none"> • Has obtained suitable specialist training for the function and for the products. • Has attended the training courses for Project Managers.
Installation personnel	<ul style="list-style-type: none"> • Assembles and installs the product components at the place of installation. • Carries out a performance check following installation. 	<ul style="list-style-type: none"> • Has received specialist training in the area of building installation technology or electrical installations.
Commissioning personnel	<ul style="list-style-type: none"> • Configure the product at the place of installation according to customer-specific requirements. • Check the product operability and release the product for use by the operator. • Searches for and corrects malfunctions. 	<ul style="list-style-type: none"> • Has obtained suitable specialist training for the function and for the products. • Has attended the training courses for commissioning personnel.
Maintenance personnel	<ul style="list-style-type: none"> • Carries out all maintenance work. • Checks that the products are in perfect working order. • Searches for and corrects malfunctions. 	<ul style="list-style-type: none"> • Has obtained suitable specialist training for the function and for the products.

Source language and reference document

- The source/original language of this document is German (de).
- The reference version of this document is the international version in English. The international version is not localized.

Document identification

The document ID is structured as follows:

ID code	Examples
ID_ModificationIndex_Language_COUNTRY -- = multilingual or international	A6V10215123_a_de_DE A6V10215123_a_en_-- A6V10315123_a_--_--

Date format

The date format in the document corresponds to the recommendation of international standard ISO 8601 (format YYYY-MM-DD).

Conventions for text marking

Markups

Special markups are shown in this document as follows:

>	Requirement for a behavior instruction
1. 2.	Behavior instruction with at least two operation sequences
–	Version, option, or detailed information for a behavior instruction
⇒	Intermediate result of a behavior instruction
⇒	End result of a behavior instruction
•	Numbered lists and behavior instructions with an operation sequence
[→ X]	Reference to a page number
'Text'	Quotation, reproduced identically
<Key>	Identification of keys
>	Relation sign and for identification between steps in a sequence, e.g., 'Menu bar' > 'Help' > 'Help topics'
↑ Text	Identification of a glossary entry

Supplementary information and tips



The 'i' symbol identifies supplementary information and tips for an easier way of working.

1.1 Applicable documents

Document ID	Title
A6V10200373	Installation Detector base with loop contact DB721, DB722, detector base DB720, sounder base DBS720, detector base seal RS720, detector locking device LP720, base attachment BA720
A6V10210416	FS720 Fire detection system - Commissioning, Maintenance, Troubleshooting
A6V10210424	FS720 Fire detection system - Configuration
A6V10229261	List of compatibility (for 'Cerberus™ PRO' product line)
A6V10277374	Data sheet Sounder interbase, Sounder beacon interbase DBS721, DBS728, DBS729
A6V10320096	Installation Sounder interbase DBS721, Sounder interbase with supplementary optical indication DBS729
A6V10882301	List of compatibility (for 'FC360' product line)

Please also observe the documentation for your fire detection system.

1.2 Download center

You can download various types of documents, such as data sheets, installation instructions, and license texts via the following Internet address:

<http://siemens.com/bt/download>

- Enter the document ID in the 'Find by keyword' input box.



You will also find information about search variants and links to mobile applications (apps) for various systems on the home page.

1.3 Technical terms and abbreviations

Term	Explanation
C-NET	Addressed detector line
ES	Product version
LED	Light Emitting Diode

1.4 Revision history

The reference document's version applies to all languages into which the reference document is translated.



The first edition of a language version or a country variant may, for example, be version 'd' instead of 'a' if the reference document is already this version.

The table below shows this document's revision history:

Modification index	Edition date	Brief description
k	2016-09-21	<ul style="list-style-type: none"> Order number for interbase seal RS721 corrected
j	2016-06-14	<ul style="list-style-type: none"> Detector base seal RS720 removed and replaced with interbase seal RS721 Amendments in the following chapters: <ul style="list-style-type: none"> 'Optical signals DBS728' 'Tones DBS728' Product line 'FC360' taken into account
i	2015-11-16	<ul style="list-style-type: none"> Reference to EN 54-23 for the DBS728 removed from the 'Mounting site' chapter. Reference to EN 54-23 for cover plate added Amendments in the following chapters: <ul style="list-style-type: none"> 'Structure and function' 'Detector base seal RS720' 'Mounting / Installation' 'Annex technical data' Seal label for cover plate added; detector locking device LP720 for cover plate removed Editorial changes
h	2015-06-30	Additions to the technical data for DBS728 (line separator, performance data); detector locking device for cover plate added
g	2015-04-17	Detector base seal RS720 added as an accessory part, changes to technical data
f	2014-12-17	Sounder beacon interbase DBS728 added; detector base seal RS720 removed as accessory part; 'activation levels' and 'escalation levels' replaced with 'alarm levels'
e	2014-02-20	Device designation changed for DBS729; change to date format in line with ISO 8601 specifications (yyyy-mm-dd format); data sheet added to 'Applicable documents' chapter; 'Download center' chapter added
d	11.2011	VdS approval and CPD number added
c	09.2011	Technical data and annex adapted
b	07.2011	Annex adapted
a	01.2011	First edition

The table below shows the published language versions with the corresponding modification index:

Modification index	en_--	de_--	fr_--	it_--	es_--
k	X	X	X	X	X
j	X	X	X	X	X
i	–	X	–	–	–
h	–	X	–	–	–
g	–	X	–	–	–
f	–	X	–	–	–
e	X	X	X	X	X
d	X	X	X	X	X
c	X	X	–	–	–
b	X	X	–	–	–
a	X	X	–	–	–

X = published

– = no publication with this modification index

2 Safety

2.1 Safety instructions

The safety notices must be observed in order to protect people and property.

The safety notices in this document contain the following elements:

- Symbol for danger
- Signal word
- Nature and origin of the danger
- Consequences if the danger occurs
- Measures or prohibitions for danger avoidance

Symbol for danger



This is the symbol for danger. It warns of **risks of injury**.
Follow all measures identified by this symbol to avoid injury or death.

Additional danger symbols

These symbols indicate general dangers, the type of danger or possible consequences, measures and prohibitions, examples of which are shown in the following table:



General danger



Explosive atmosphere



Voltage/electric shock



Laser light



Battery



Heat

Signal word

The signal word classifies the danger as defined in the following table:

Signal word	Danger level
DANGER	DANGER identifies a dangerous situation, which will result directly in death or serious injury if you do not avoid this situation.
WARNING	WARNING identifies a dangerous situation, which may result in death or serious injury if you do not avoid this situation.
CAUTION	CAUTION identifies a dangerous situation, which could result in slight to moderately serious injury if you do not avoid this situation.
<i>NOTICE</i>	<i>NOTICE</i> identifies possible damage to property that may result from non-observance.

How risk of injury is presented

Information about the risk of injury is shown as follows:

	<p>⚠ WARNING</p>
	<p>Nature and origin of the danger Consequences if the danger occurs</p> <ul style="list-style-type: none"> • Measures / prohibitions for danger avoidance

How possible damage to property is presented

Information about possible damage to property is shown as follows:



	<p><i>NOTICE</i></p>
	<p>Nature and origin of the danger Consequences if the danger occurs</p> <ul style="list-style-type: none"> • Measures / prohibitions for danger avoidance

2.2 Safety regulations for the method of operation

National standards, regulations and legislation

Siemens products are developed and produced in compliance with the relevant European and international safety standards. Should additional national or local safety standards or legislation concerning the planning, mounting, installation, operation or disposal of the product apply at the place of operation, then these must also be taken into account together with the safety regulations in the product documentation.

Electrical installations

	<p>⚠ WARNING</p>
	<p>Electrical voltage Electric shock</p> <ul style="list-style-type: none"> • Work on electrical installations may only be carried out by qualified electricians or by instructed persons working under the guidance and supervision of a qualified electrician, in accordance with the electrotechnical regulations.
<ul style="list-style-type: none"> • Wherever possible disconnect products from the power supply when carrying out commissioning, maintenance or repair work on them. • Lock volt-free areas to prevent them being switched back on again by mistake. • Label the connection terminals with external voltage using a 'DANGER External voltage' sign. • Route mains connections to products separately and fuse them with their own, clearly marked fuse. • Fit an easily accessible disconnecting device in accordance with IEC 60950-1 outside the installation. • Produce earthing as stated in local safety regulations. 	
	<p>⚠ CAUTION</p>
	<p>Noncompliance with the following safety regulations Risk of injury to persons and damage to property</p> <ul style="list-style-type: none"> • Compliance with the following regulations is required.
	<ul style="list-style-type: none"> • Specialist electrical engineering knowledge is required for installation. • Only an expert is permitted to carry out installation work. <p>Incorrect installation can take safety devices out of operation unbeknown to a layperson.</p>

Mounting, installation, commissioning and maintenance

- If you require tools such as a ladder, these must be safe and must be intended for the work in hand.
- When starting the fire control panel ensure that unstable conditions cannot arise.
- Ensure that all points listed in the 'Testing the product operability' section below are observed.
- You may only set controls to normal function when the product operability has been completely tested and the system has been handed over to the customer.

Testing the product operability

- Prevent the remote transmission from triggering erroneously.
- If testing building installations or activating devices from third-party companies, you must collaborate with the people appointed.
- The activation of fire control installations for test purposes must not cause injury to anyone or damage to the building installations. The following instructions must be observed:
 - Use the correct potential for activation; this is generally the potential of the building installation.
 - Only check controls up to the interface (relay with blocking option).
 - Make sure that only the controls to be tested are activated.
- Inform people before testing the alarm devices and allow for possible panic responses.
- Inform people about any noise or mist which may be produced.
- Before testing the remote transmission, inform the corresponding alarm and fault signal receiving stations.

Modifications to the system design and the products

Modifications to the system and to individual products may lead to faults, malfunctioning and safety risks. Written confirmation must be obtained from Siemens and the corresponding safety bodies for modifications or additions.

Modules and spare parts

- Components and spare parts must comply with the technical specifications defined by Siemens. Only use products specified or recommended by Siemens.
- Only use fuses with the specified fuse characteristics.
- Wrong battery types and improper battery changing lead to a risk of explosion. Only use the same battery type or an equivalent battery type recommended by Siemens.
- Batteries must be disposed of in an environmentally friendly manner. Observe national guidelines and regulations.

Disregard of the safety regulations

Before they are delivered, Siemens products are tested to ensure they function correctly when used properly. Siemens disclaims all liability for damage or injuries caused by the incorrect application of the instructions or the disregard of danger warnings contained in the documentation. This applies in particular to the following damage:

- Personal injuries or damage to property caused by improper use and incorrect application
- Personal injuries or damage to property caused by disregarding safety instructions in the documentation or on the product
- Personal injury or damage to property caused by poor maintenance or lack of maintenance

2.3 Standards and directives complied with

A list of the standards and directives complied with is available from your Siemens contact.

2.4 Release Notes

Limitations to the configuration or use of devices in a fire detection installation with a particular firmware version are possible.

	⚠ WARNING
	<p>Limited or non-existent fire detection</p> <p>Personal injury and damage to property in the event of a fire.</p> <ul style="list-style-type: none"> • Read the 'Release Notes' before you plan and/or configure a fire detection installation. • Read the 'Release Notes' before you carry out a firmware update to a fire detection installation.

	NOTICE
	<p>Incorrect planning and/or configuration</p> <p>Important standards and specifications are not satisfied. Fire detection installation is not accepted for commissioning. Additional expense resulting from necessary new planning and/or configuration.</p> <ul style="list-style-type: none"> • Read the 'Release Notes' before you plan and/or configure a fire detection installation. • Read the 'Release Notes' before you carry out a firmware update to a fire detection installation.

3 Structure and function

3.1 Overview of DBS721

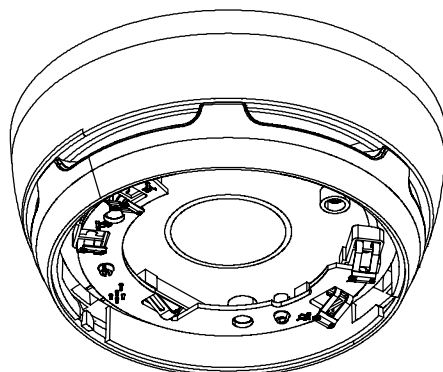

Figure 1: View of the DBS721

The sounder interbase DBS721 provides an acoustic alarm in an addressed fire detection system FS720.

The sounder interbase DBS721 can be activated by any point detector via the control panel.

The loud sound of the interbase can be clearly recognized as a danger signal in the event of a fire alarm.

11 tones are programmed in the interbase. Two alarm levels can be activated for different events (e.g. alarm and evacuation).

If a point detector is not used, the cover plate BP720 (accessory) can be fitted on the interbase.

Features

- Addressable on the C-NET detector loop
- Communication with the control panel via the detector loop
- Supply via detector loop
- Compatible with all detector bases from the product line 'Cerberus PRO'
- Compatible with all point detectors from the product line 'Cerberus PRO'
- Integrated line separation function
- Self test function
- Yellow LED in interbase to indicate servicing required
- Synchronization of sounds with all alarm sounders, interbases and audible bases on the same detector loop
- No additional detector base required

3.2 Overview of DBS728

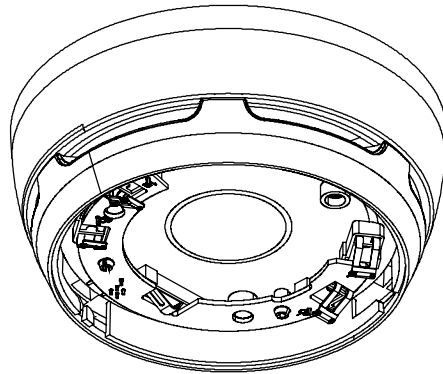

Figure 2: View of the DBS728

The sounder beacon interbase DBS728 provides an optical and acoustic alarm in an addressed fire detection system FS720.

The sounder beacon interbase DBS728 can be activated by any point detector via the control panel.

If a fire alarm is triggered, the loud sound of the interbase can be clearly recognized as a danger signal and white LEDs give a visual indication of the danger situation.

13 tones are programmed in the interbase. Two alarm levels can be activated for different events (e.g. alarm and evacuation).

There are two programmable brightness levels, 'dark/low' and 'light/high'.

If a point detector is not used, the cover plate BP720 (accessory) can be fitted on the interbase.

Features

- Addressable on the C-NET detector loop
- Communication with the control panel via the detector loop
- Supply via detector loop
- Compatible with all detector bases from the product line 'Cerberus PRO'
- Compatible with all point detectors from the product line 'Cerberus PRO'
- Integrated line separation function
- Self test function
- Yellow LED in interbase to indicate servicing required
- Synchronization of sounds with all alarm sounders, interbases and audible bases on the same detector loop
- No additional detector base required
- Optical indicator as alarm signal
- Synchronization of the optical indication from all DBS728 on one detector line
- Meets the specifications of the EN 54-23 standard – flashes brighter than the interbase DBS729

3.3 Overview of DBS729

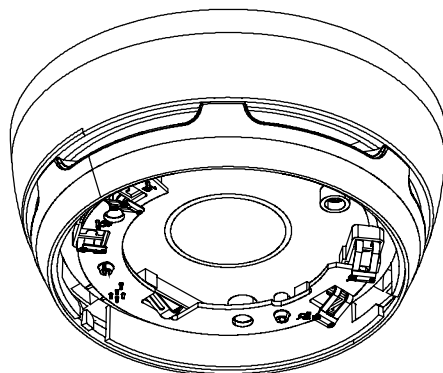

Figure 3: View of the DBS729

The DBS729 sounder interbase with supplementary optical indication provides an acoustic alarm in an addressed FS720 fire detection system. It also features a optical display.

The DBS729 sounder interbase with supplementary optical indication can be activated by any point detector via the control panel.

The loud sound of the interbase can be clearly recognized as a danger signal in the event of a fire alarm. The LEDs on the additional optical display also light up.



The additional optical display does not serve the purpose of evacuation in accordance with the area of application of EN 54-23.

11 tones are programmed in the interbase. Two alarm levels can be activated for different events (e.g. alarm and evacuation).

There are three programmable luminous intensity levels and two programmable flashing patterns. This means that there are six adjustment options available.

If a point detector is not used, the cover plate BP720 (accessory) can be fitted on the interbase.

Features

- Addressable on the C-NET detector loop
- Communication with the control panel via the detector loop
- Supply via detector loop
- Compatible with all detector bases from the product line 'Cerberus PRO'
- Compatible with all point detectors from the product line 'Cerberus PRO'
- Integrated line separation function
- Self test function
- Yellow LED in interbase to indicate servicing required
- Synchronization of sounds with all alarm sounders, interbases and audible bases on the same detector loop
- No additional detector base required
- Additional optical display

3.4 Details for ordering

Type	Order no.	Designation
DBS721	S54372-F13-A1	Sounder interbase
DBS728	S54372-F14-B1	Sounder beacon interbase
DBS729	S54372-F14-A1	Sounder interbase with additional optical indicator

3.5 Product version ES

The product version ES provides the technical status of a device in terms of software and hardware. The product version is provided as a two-digit number.

You will find the details of your device's product version:

- On the packaging label
- On the product label or the type plate

Product version on the packaging label

Details of the product version can be found directly on the packaging label in the barcode:

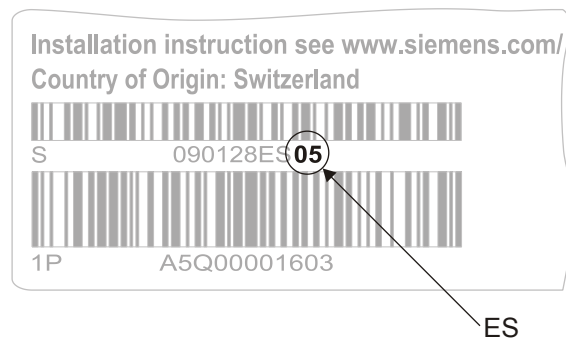

Figure 4: Example of a packaging label with details of the product version

Product version on the product label and the type plate

Details of the product version can be found after the device order number:

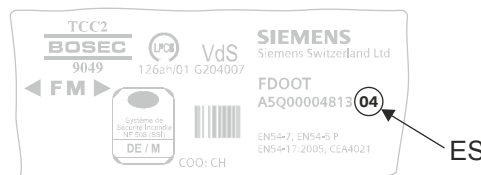

Figure 5: Example of a product label with details of the product version



Depending on the product and various approvals, the product labels may differ in terms of the information type and layout.

Look for your device's order number on the product label.

You will find the product version after the order number.

3.6 Function

3.6.1 Configuration

The configuration influences the behavior of the devices so it can be specifically adjusted to the anticipated conditions in the monitored environment.

All settings are programmed in the devices. During commissioning, the optimum setting must be selected for the conditions at the place of installation.

You can configure the settings as follows:

- Using the 'Cerberus-Engineering-Tool' software
- Directly on your fire detection system

A description of the exact configuration procedure can be found in the relevant documentation.



Observe the 'Applicable documents' section in the 'About this document' chapter.

See also

- [Applicable documents \[→ 7\]](#)
- [Acoustic and optical configuration \[→ 26\]](#)

3.6.2 Alarm levels and sound levels

Sounder interbase DBS721

The sounder interbase DBS721 can be activated for the following selectable alarm levels:

- Warning (Alert)
- Evacuation (EVAC)

The tone can be configured individually for each of the two selectable alarm levels from 11 different tones and the sound level can be configured by interbase.

There are three sound levels available: One alarm sound level according to EN 54-3 and two test sound levels.

Sounder beacon interbase DBS728

The sounder beacon interbase DBS728 can be activated for the following selectable alarm levels:

- Warning (Alert)
- Evacuation (EVAC)

The tone can be configured individually for each of the two selectable alarm levels from 13 different tones and the sound level can be configured by device. There are two sound levels available: One alarm sound level according to EN 54-3 and one test sound level.

The LEDs have a set flashing frequency of 0.5 Hz and can be used as follows:

Configuration of LEDs	Description
Activation with both alarm levels (default)	The LEDs also flash whenever the interbase is active.
Activation only with second alarm level (evacuation)	The LEDs only flash when the second alarm level is activated.
Activation with degraded fire alarm only	The LEDs are only activated as an additional alarm signal in the event of a degraded fire alarm.
Switched off	LEDs are never activated, i.e. the DBS728 behaves like a DBS721.



The degraded fire alarm is a fire alarm which occurs during degraded mode operation of the fire control panel. Degraded mode operation is a defined reduced operating mode which occurs when part of the fire detection installation fails.

Sounder interbase with supplementary optical indication DBS729

The sounder interbase with supplementary optical indication DBS729 can be activated for the following selectable alarm levels:

- Warning (Alert)
- Evacuation (EVAC)

The tone can be configured individually for each of the two selectable alarm levels from 11 different tones and the sound level can be configured by device. There are three sound levels available: One alarm sound level according to EN 54-3 and two test sound levels.

The LEDs have a set flashing frequency of about 0.8 Hz and can be used as follows:

Configuration of LEDs	Description
Activation with both alarm levels (default)	The LEDs also flash whenever the interbase is active.
Activation only with second alarm level (evacuation)	The LEDs only flash when the second alarm level is activated.
Activation with degraded fire alarm only	The LEDs are only activated as an additional indicator in the event of a degraded fire alarm.
Switched off	LEDs are never activated, i.e. the DBS729 behaves like a DBS721.



The degraded fire alarm is a fire alarm which occurs during degraded mode operation of the fire control panel. Degraded mode operation is a defined reduced operating mode which occurs when part of the fire detection installation fails.

See also

Behavior in degraded mode [→ 21]

3.6.3 Behavior in degraded mode

Applicable for the C-NET:

When the main processor of the fire control panel fails, the control panel works in degraded mode operation. Depending on the control panel type, the fire control panel can continue to perform the most important alarming and signaling functions in degraded mode operation.

The interbases DBS721, DBS728, and DBS729 are also activated and deactivated in case of a fire alarm in degraded mode operation.

Degraded mode operation on the C-NET is not supported in the same way by all control panels. The information in the 'List of compatibility' and in the corresponding control panel documentation must be taken into account during project planning.

3.6.4 Service indicator

The interbases DBS721, DBS728, and DBS729 have a yellow LED to indicate when servicing is required.

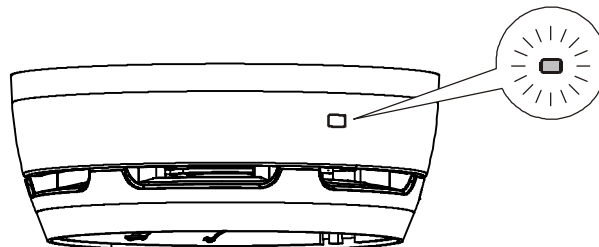
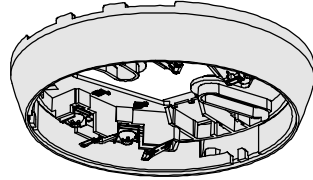

Figure 6: Service indicator

Behavior of LED	Mode	Meaning
LED flashes	Locate	Displays the interbase location

3.7 Accessories

3.7.1 Detector base with loop contact DB721



- For the mounting of point detectors
- Thanks to the loop contacts, the detector line is not interrupted when there is no point detector installed in the detector base.
- For the recess-mounted cable entry
- For surface-mounted cable entry, up to 8 mm cable diameter
- Cable connection via screw terminals
- Compatible with:
 - Multi-sensor fire detector OH720
 - Smoke detector OP720
 - Heat detector HI720
 - Heat detector HI722
 - Multi-sensor smoke detector, ASA OOH740
 - Neural fire detector OOH740
 - Interbase DBS72x
 - Air sampling smoke detection kit FDBZ290
- Order number: S54319-F11-A1

See also

📄 Mounting/Installation [→ 32]

3.7.2 Cover plate BP720

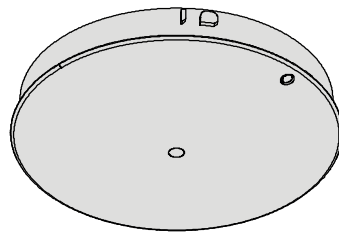

- To protect the interbase from dirt
- EN 54-23
- Self-adhesive seal label in scope of delivery
- Compatible with:
 - Sounder interbase DBS721
 - Sounder beacon interbase DBS728
 - Sounder interbase with additional optical indicator DBS729
 - Detector locking device LP720
- Order number: S54372-B12-A1

3.7.3 Interbase seal RS721

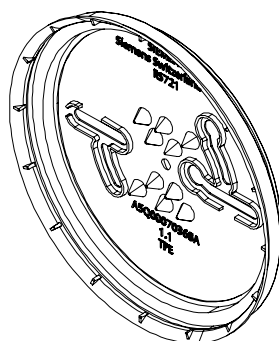

- For mounting in wet rooms
- Protection category IP21C
- Compatible with:
 - Sounder interbase DBS721
 - Sounder beacon interbase DBS728
 - Sounder interbase with additional optical indicator DBS729
- Order number: S54319-F32-A1

3.7.4 Designation plate DBZ1193A

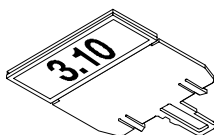

- To identify the location
- Compatible with:
 - Base attachment wet FDB295/BA721
 - Base attachment, surface-mounted, humid DBZ1192
 - DBW1171 base
 - Interbase DBS72x
- Order number: BPZ:4864330001

See also

- 📄 Mounting/Installation [→ 32]

3.7.5 Detector locking device LP720

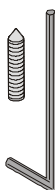

- For protection against theft
- Compatible with:
 - Multi-sensor fire detector OH720
 - Smoke detector OP720
 - Heat detector HI720
 - Heat detector HI722
 - Multi-sensor fire detector OOH740
 - Multi-sensor fire detector OOH740
 - Interbase DBS72x
- Order number: S54319-F9-A1

See also

- 📄 Detector locking device LP720 [→ 34]
- 📄 Cover plate BP720 [→ 35]

3.7.6 Micro terminal DBZ1190-AA

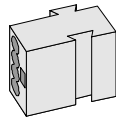

- Auxiliary terminal for connecting cables
- For T-branches of additional cabling e.g. for detector heating units, sounder base, external alarm indicators etc.
- For conductor cross-sections of 0.28...0.5 mm²
- 4-pin
- Order number: BPZ:4677080001

3.7.7 Connection terminal DBZ1190-AB

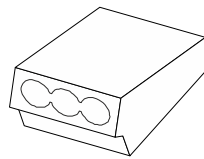

- Auxiliary terminal for connecting cables
- For T-branches of additional cabling, e.g., for cable shielding, detector heating units, sounder base, external alarm indicators, etc.
- For conductor cross-sections of 1...2.5 mm²
- 3 poles
- Order number: BPZ:4942340001

4 Planning

Please always take the country-specific provisions and the alarm organization for project planning into account. In addition, the connection factors stated in the specifications must also be taken into account.

4.1 Compatibility

The table below shows the compatibility of the interbases DBS721, DBS728, and DBS729 with various control panels:

Detector line	Control panel				
	FC20xx	FC72x	SIGMASYS	AlgoRex	FC361-xx
C-NET	–	X	–	–	X

X = compatible

– = not compatible

You will find details in the 'List of compatibility'.

See also

 [Applicable documents \[→ 7\]](#)

4.2 Fields of application

Typical areas of use for the interbases DBS721, DBS728, and DBS729 include:

- Hotel rooms
- Restrooms
- Offices

4.3 Mounting site

The DBS721 and DBS729 interbases can be mounted on the ceiling or the wall. The interbase DBS728 may only be mounted on the ceiling.

When positioning the DBS728 and DBS729 interbases, bear in mind the beam angle of the LEDs.

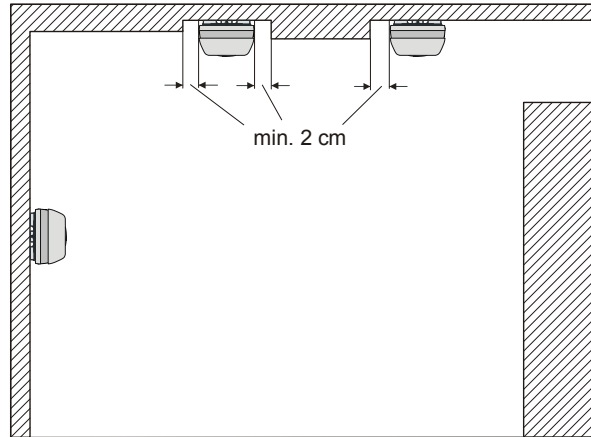

Figure 7: Mounting the interbases on the wall or ceiling (DBS728 mounted on ceiling only)

4.4 Limitations

- The optical signals between the interbase DBS728 and the interbase DBS729 cannot be synchronized.

Synchronizing optical signals between different device types	DBS728	DBS729
DBS728	X	–
DBS729	–	X

X = synchronization possible

– = synchronization not possible

4.5 Acoustic and optical configuration



The following chapters contain the specifications of the different acoustic signals and optical indicators.

The optical indicators are only available with interbases DBS728 and DBS729.

See also

 Configuration [→ 19]

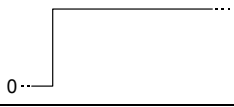
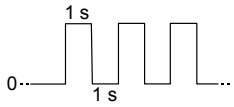
4.5.1 DBS721 and DBS729 acoustic signals

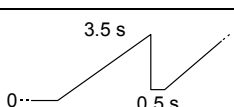
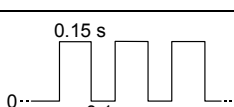
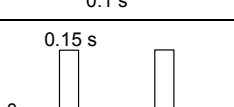
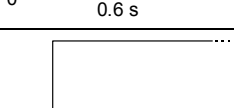
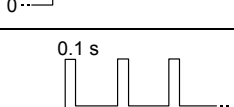
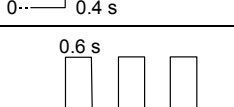
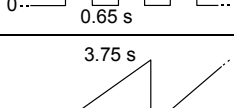
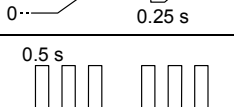
No.	Tone	Frequency pattern Sweep from → to	Pulse pattern	Adjustable max. sound levels with cover plate (typ. values in [dBA/1m] ¹)		Norm
				at 12 V	at 32 V	
1	Continuous	970 Hz		83	86	'evacuate' BS 5839 Part 1 1988
2	Intermittent	950 Hz		85	89	'alert' BS 5839 Part 1 1988
3	Sweep-down	1,200 Hz → 500 Hz		86	87	DIN tone DIN 33404 Part 3
4	Slow-whoop Sweep-up, linear	500 Hz → 1,200 Hz		86	88	NEN 2575 (Netherlands)
5	Pulse tone	500 Hz		81	82	Swedish Standard SS 03 17 11, No. 1 'Imminent Danger'
6	Intermittent	500 Hz		80	82	Swedish Standard SS 03 17 11, No. 6 'Local Warning'
7	Continuous	500 Hz		82	83	Swedish Standard SS 03 17 11, No. 4 'All clear'
8	Alternating	560 Hz 440 Hz		82	84	'French fire sound' NF S 32-001-1975
9	Intermittent	420 Hz		81	83	Australia 'Alert' AS 2220 -1978
10	Slow-whoop Sweep-up, linear	500 Hz → 1,200 Hz		87	88	Australia 'Action' AS 2220 -1978
11	Intermittent	970 Hz		84	86	ISO 8201 US Temporal Tone LF
31	Mute	Alarm sounder is switched off so that the DBS729 can be operated as an optical indicator.				

¹ The sound level depends on the angle. See 'Annex technical data'

See also

 Tones and sound levels of the interbase [→ 46]

4.5.2 DBS729 optical signals

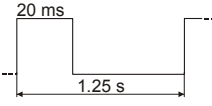
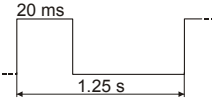
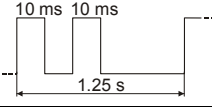
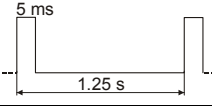
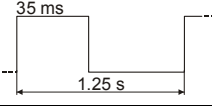
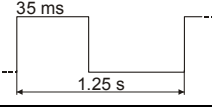
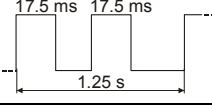
No.	Flash type	Flashing frequency	Pulse pattern	Luminous intensity at 32 V, angle-dependent (typ.)	Standard / Notes
0	Flash	0.8 Hz		Normal	—
1	Flash	0.8 Hz		Normal	Monitoring function ¹
2	Alternating ²	0.8 Hz		Normal	—
3	Flash	0.8 Hz		Dark	—
4	Flash	0.8 Hz		Bright	—
5	Flash	0.8 Hz		Bright	Monitoring function ¹
6	Alternating ²	0.8 Hz		Bright	—
7	Reserve	—	—	—	—





¹ Supervision function: The LEDs are activated once approx. every 4.5 hours and flash 4 times in succession.

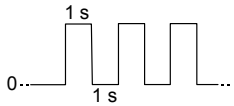

² In alternating mode, only half of the LEDs flash. After a pause of 50 ms the other half flash.

See also

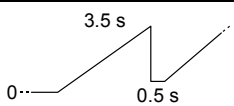
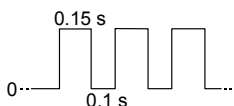
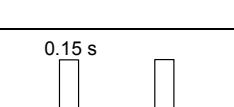
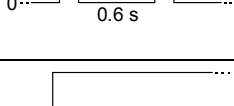
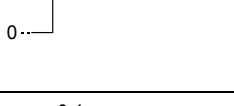
-  Optical beam characteristics of interbase DBS729 (DC 32 V) [→ 52]

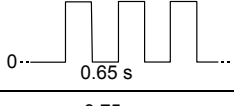
4.5.3 DBS728 acoustic signals

No.	Tone	Frequency pattern Sweep from → to	Pulse pattern	Adjustable max. sound levels with cover plate (typ. values in [dBA/1m] 1)		Standards
				at 12 V	at 32 V	
1	Continuous	970 Hz		89	93	'evacuate' BS 5839 Part 1 1988, EN 54-3
2	Intermittent	950 Hz		90	93	'alert' BS 5839 Part 1 1988, EN 54-3
3	Sweep-down	1,200 Hz → 500 Hz		88	91	DIN tone DIN 33404 Part 3, EN 54-3
4	Slow-whoop Sweep-up, linear	500 Hz → 1,200 Hz		88	90	NEN 2575 (Netherlands) EN 54-3
5	Pulse tone	500 Hz		86	89	Swedish Standard SS 03 17 11, No. 1 'Imminent Danger', EN 54-3
6	Intermittent	500 Hz		86	89	Swedish Standard SS 03 17 11, No. 6 'Local Warning', EN 54-3
7	Continuous	500 Hz		86	89	Swedish Standard SS 03 17 11, No. 4 'All clear', EN 54-3
8	Alternating	560 Hz 440 Hz		86	88	'French fire sound' NF S 32-001 -1975, EN 54-3
9	Intermittent	420 Hz		85	87	Australia 'Alert' AS 2220 -1978, EN 54-3
10	Slow-whoop Sweep-up, linear	500 Hz → 1,200 Hz		88	91	Australia 'Action' AS 2220 -1978, EN 54-3

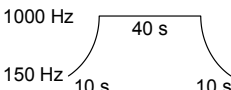
No.	Tone	Frequency pattern Sweep from → to	Pulse pattern	Adjustable max. sound levels with cover plate (typ. values in [dBA/1m] ¹)		Standards
				at 12 V	at 32 V	
11	Intermittent	970 Hz		89	92	ISO 8201 US Temporal Tone LF, EN 54-3
12	Sweep-up	800 → 970 Hz		89	91	BS fire tone
13	Sweep-up, continuous, slow-whoop	150 → 1000 → 150 Hz		87	90	DE industrial alarm
31	Mute	Alarm sounder is switched off so that the DBS728 can be operated as an optical indicator.				

¹ The sound level depends on the angle. See 'Annex technical data'

4.5.4 DBS728 optical signals

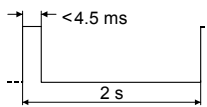
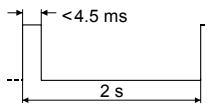
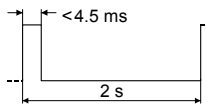
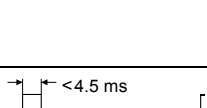
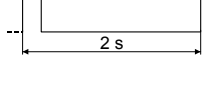
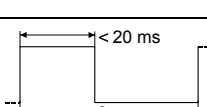
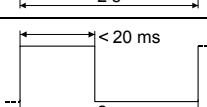
No.	Flash type	Flashing frequency	Pulse pattern	Luminous intensity at 32 V, angle-dependent (typ.)	Standard / Notes
0	Flash	0.5 Hz		Dark/low	—
1	Flash	0.5 Hz		Dark/low	Monitoring function ¹
2	Flash	0.5 Hz		Dark/low	<ul style="list-style-type: none"> Parameter is not visible in the 'Cerberus-Engineering-Tool' Listed as a duplicate of parameter '0' for backward compatibility
3	Flash	0.5 Hz		Dark/low	<ul style="list-style-type: none"> Parameter is not visible in the 'Cerberus-Engineering-Tool' Listed as a duplicate of parameter '0' for backward compatibility
4	Flash	0.5 Hz		Light/high	—
5	Flash	0.5 Hz		Light/high	Monitoring function ¹
6	Flash	0.5 Hz		Light/high	<ul style="list-style-type: none"> Parameter is not visible in the 'Cerberus-Engineering-Tool' Listed as a duplicate of parameter '4' for backward compatibility
7	Reserve	—	—	—	—

¹ Supervision function: The LEDs are activated once approx. every 4.5 hours.

5 Mounting/Installation

The interbases DBS721, DBS728, and DBS729 require a mounted detector base from the 'Cerberus PRO' product line.



The interbase DBS728 may only be mounted on the ceiling.

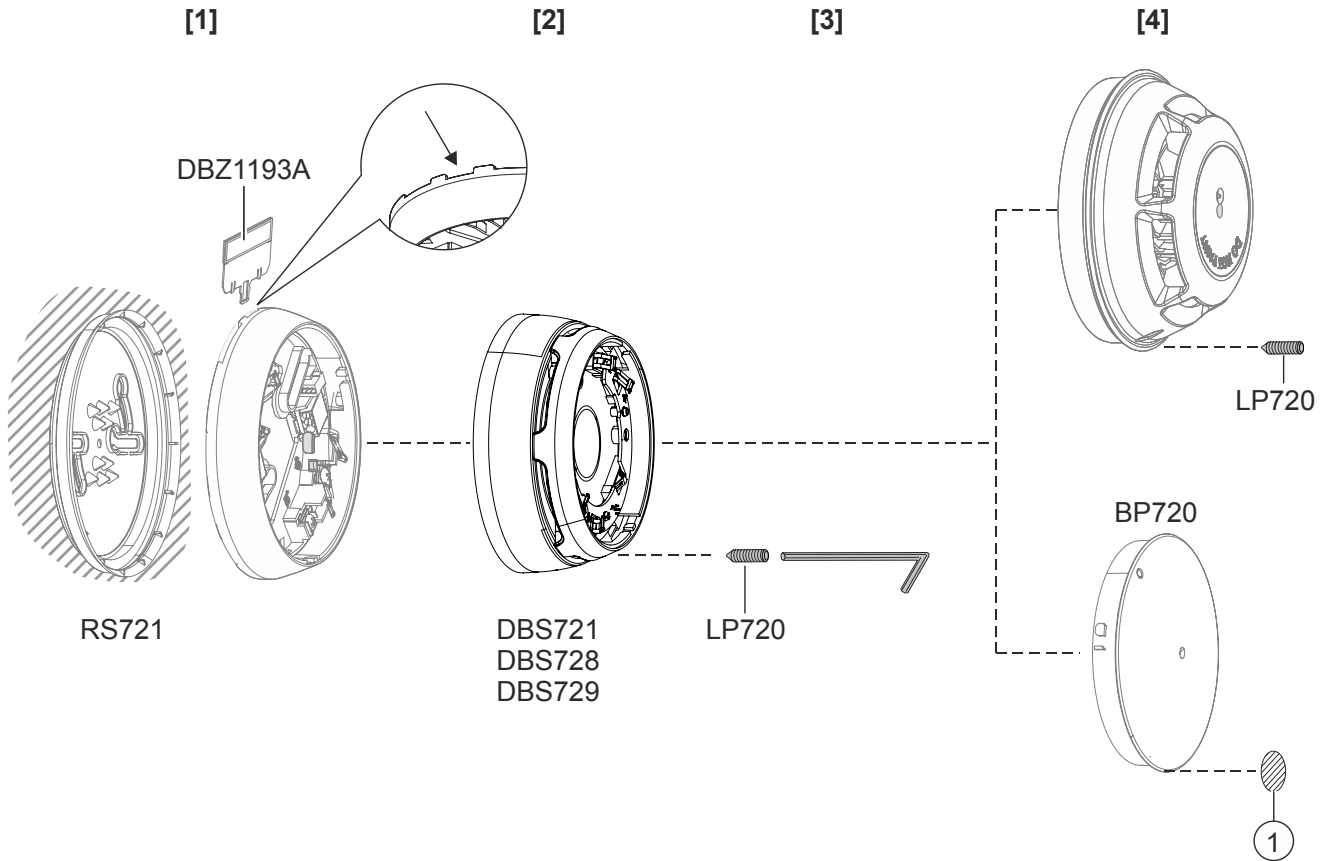

1 Seal label

Mounting sequence	
[1]	Detector base without point detector
[2]	Mounting of the interbase
[3]	Mounting of the detector locking device
[4]	Mounting of the point detector or cover plate BP720



⚠ WARNING

Danger of falling

- ▷ Danger of injury
- When installing, use a secured ladder or work platform.

Mounting

- ▷ The detector base is fitted and installed.
 - ▷ The detector base is in a location that allows for the beam angle in the DBS728 and DBS729.
 - ▷ The previously fitted point detector has been removed from the detector base.
1. Install the required accessories: LP720, DBZ1193A.
 2. Place the interbase on the detector base and turn it clockwise until it snaps into place.
 3. Place either the cover plate BP720 or the point detector on the interbase and turn it clockwise until it snaps into place.
- ⇒ The interbase is connected to the detector base and ready for use.

Removing the interbase

1. Remove the point detector.
2. Release the interbase's detector locking device.
3. Unscrew the interbase from the detector base by turning counter-clockwise.

5.1 Detector locking device LP720

Using a detector locking device LP720 protects an interbase DBS721, DBS728 or DBS729 against theft.

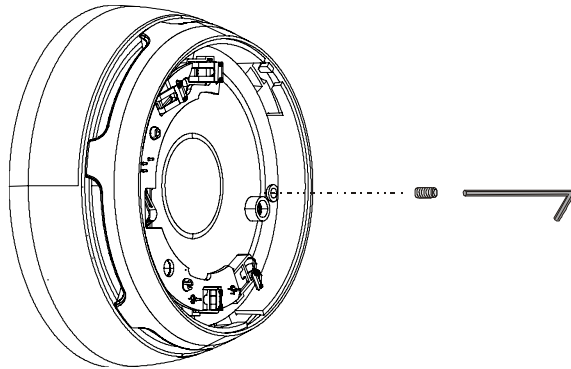

Figure 8: Detector locking device LP720

1. Use the Allen key provided to insert the set screw into the interbase from the detector side by turning a few revolutions.
2. Screw the interbase into the detector base.
3. Screw the set screw back in until it touches the detector base.



The point detector mounted in the interbase can be protected against theft with another detector locking device LP720.

See also

- Detector locking device LP720 [→ 23]

5.2 Cover plate BP720

The cover plate BP720 protects the interbase DBS721, DBS728 or DBS729 if a point detector is not being used. The cover plate is a visual element and has no electrical function.

- ▷ The interbase is fitted in the detector base.
 - ▷ A seal label (1) is available.
 - ▷ The surfaces to which the seal label (1) is to be attached are grease-free.
1. Place the cover plate BP720 on the interbase.
 2. Turn the cover plate clockwise until it snaps into place.
 3. Attach the self-adhesive seal label (1) supplied (see graphics). The seal label (1) is attached above the sounder opening bar that is nearest to the horizontal zero point of the interbase. Equal parts of the seal label (1) must be attached to the interbase and the cover plate.
 - Press the seal label (1) on firmly.
- ⇒ The interbase is ready for use.

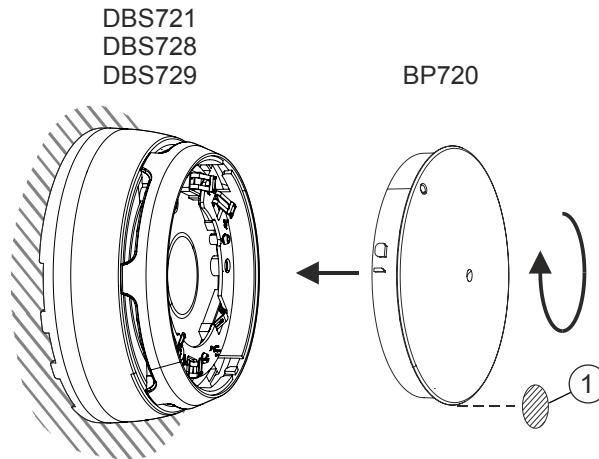

Figure 9: Mounting of the cover plate BP720

1 Seal label

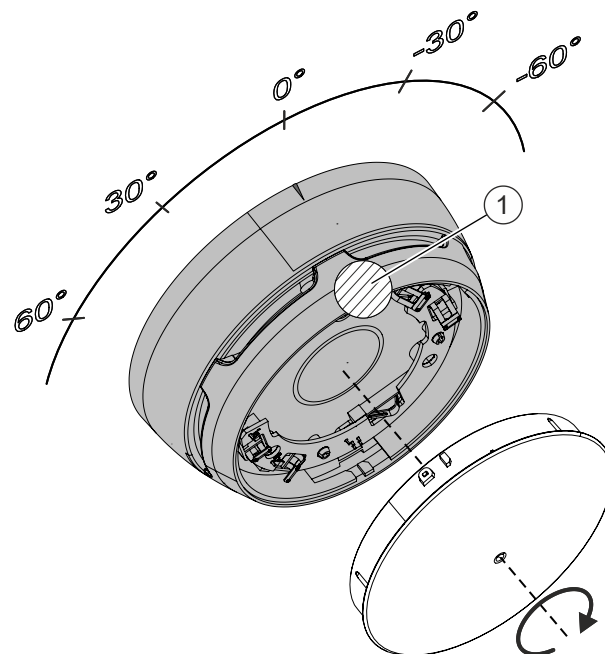

Figure 10: Position of the seal label

1 Seal label

See also

📄 Detector locking device LP720 [→ 23]

6 Commissioning

The devices are commissioned via the control panel. The exact procedure is described in the control panel documentation.

Conduct a performance check once commissioning is complete.

7 Maintenance / Repair

7.1 Status query

The following actions can be performed from the control panel:

- Commissioning
- Configure sounds
- Activate / deactivate sound
- Activate/deactivate LEDs (only with interbases DBS728 and DBS729)
- Read error list / status register

8 Specifications

8.1 Technical data DBS721

You will find information on approvals, CE marking, and the relevant EU directives for this device (these devices) in the following document(s); see 'Applicable documents' chapter:

- Document A6V10277374

Detector line	Operating voltage	DC 12...33 V
	Operating current:	
	• Standby	Max. 250 μ A
	• Sound activated	3.5 mA
	Quiescent current connection factor	1
	Address connection factor	1
	Separator connector factor	1
	Protocol	C-NET
	System compatibility	See 'List of compatibility'
	Connection factor: Sound activated	15
Line separator	Line voltage:	
	• Nominal	DC 32 V (= V_{nom})
	• Minimum	DC 12 V (= V_{min})
	• Maximum	DC 33 V (= V_{max})
	Voltage at which the line separator opens:	
	• Minimum	DC 7.5 V (= $V_{SO min}$)
	• Maximum	DC 10.5 V (= $V_{SO max}$)
	Permanent current when switches are closed	Max. 0.5 A (= $I_{C max}$)
	Switching current (e.g., in the event of a short-circuit)	Max. 1 A (= $I_S max$)
	Leakage current when switches are open	Max. 1 mA (= $I_L max$)
	Serial impedance when switches are closed:	
	• Point detector not used	0.5 Ω (= $Z_C max$)
• Point detector used	2x 0.5 Ω	
Function	Number of selectable tones	11
	Number of programmable alarm levels	2
	Number of programmable sound levels:	3
	• 1 alarm sound level according to EN 54-3	
	• 2 test sound levels	
	Adjustable maximum sound levels (typical values in dBA/m at DC 32 V with blanking plate BP720) For details, see 'Annex technical data'	82...89 dBA

Ambient conditions	Operating temperature	-25...+55 °C
	Storage temperature	-30...+75 °C
	Air humidity	≤95 % rel.
	Protection category (IEC 60529) with interbase seal RS721:	
	• When using the point detector	IP21C
	• With blanking plate BP720	IP21C
	Electromagnetic compatibility at:	
	• 1 MHz...1 GHz	50 V/m
	• 1 GHz...2 GHz	30 V/m
	Mechanical data	Dimensions (Ø x H)
Weight DBS721		225 g
Weight BP720		27 g
Material		Polycarbonate (PC)
Color:		
• Outside		Translucent
• Body		~RAL 9010 pure white
Standards	European standards	• EN 54-3, type A
		• EN 54-17

8.2 Technical data DBS728

You will find information on approvals, CE marking, and the relevant EU directives for this device (these devices) in the following document(s); see 'Applicable documents' chapter:

- Document A6V10277374

Detector line	Operating voltage	DC 12...33 V	
	Operating current:		
	• Standby	Max. 250 μ A	
	• Sound activated	3.6 mA (115 mW)	
	• Light activated (luminous intensity low/high)	3.0/7.8 mA (65/130 mW)	
	• Sound and light activated (luminous intensity low/high)	5.6/10.6 mA (160/225 mW)	
	Quiescent current connection factor	1	
	Address connection factor	1	
	Separator connector factor	1	
	Protocol	C-NET	
	System compatibility	See 'List of compatibility'	
	Connection factor:		
	• Sound activated	15	
	• Light activated (luminous intensity low/high)	13/32	
	• Sound and light activated (luminous intensity low/high)	23/43	
	Line separator	Line voltage:	
• Nominal		DC 32 V (= V_{nom})	
• Minimum		DC 12 V (= V_{min})	
• Maximum		DC 33 V (= V_{max})	
Voltage at which the line separator opens:			
• Minimum		DC 7.5 V (= $V_{SO min}$)	
• Maximum		DC 10.5 V (= $V_{SO max}$)	
Permanent current when switches are closed		Max. 1.5 A (= $I_{C max}$)	
Switching current (e.g., in the event of a short-circuit)		Max. 2 A (= $I_S max$)	
Leakage current when switches are open		Max. 1 mA (= $I_L max$)	
Serial impedance when switches are closed:			
• Point detector not used		0.5 Ω (= $Z_C max$)	
• Point detector used		2x 0.5 Ω	
The line separator is closed via an actuation signal from the control panel. Required line voltage: DC 12...33 V (normal range)			

Function	Number of selectable tones	13
	Number of programmable alarm levels	2
	Number of programmable sound levels:	2
	<ul style="list-style-type: none"> • 1 alarm sound level according to EN 54-3 • 1 test sound level 	
	Adjustable maximum sound levels (typical values in dBA/m at DC 32 V with blanking plate BP720) For details, see 'Annex technical data'	77...93 dBA
	Number of flashing modes	1
	Number of programmable luminous intensity levels (not available with all control panels)	2
	Luminous intensity according to EN 54-23	C-3-5 light/high O-1.5-2.4 dark/low (ceiling-mounted, cylindrical cover cap as in Class C)
Ambient conditions	Operating temperature	-25...+55 °C
	Storage temperature	-30...+75 °C
	Air humidity	≤95 % rel.
	Protection category (IEC 60529) with interbase seal RS721:	
	<ul style="list-style-type: none"> • When using the point detector • With blanking plate BP720 	IP21C IP21C
	Electromagnetic compatibility at:	
	<ul style="list-style-type: none"> • 1 MHz...1 GHz • 1 GHz...2 GHz 	50 V/m 30 V/m
Mechanical data	Dimensions (Ø x H)	127.4 x 51.6 mm
	Weight DBS728	0.232 kg
	Weight BP720	27 g
	Material	Polycarbonate (PC)
	Color:	
	<ul style="list-style-type: none"> • Outside • Body 	Translucent ~RAL 9010 pure white
Standards	European standards	<ul style="list-style-type: none"> • EN 54-3, type A • EN 54-17 • EN 54-23, type A, Class C and O

8.3 Technical data DBS729

You will find information on approvals, CE marking, and the relevant EU directives for this device (these devices) in the following document(s); see 'Applicable documents' chapter:

- Document A6V10277374

Detector line	Operating voltage	DC 12...33 V
	Operating current:	
	• Standby	Max. 250 μ A
	• Sound activated	3.5 mA
	• Light activated (luminous intensity low/medium/high)	1.5/4.0/6.5 mA
	• Sound and light activated (luminous intensity low/medium/high)	5.0/7.5/10.5 mA
	Quiescent current connection factor	1
	Address connection factor	1
	Separator connector factor	1
	Protocol	C-NET
	System compatibility	See 'List of compatibility'
	Connection factor:	
	• Sound activated	15
	• Light activated (luminous intensity low/medium/high)	6/16/26
	• Sound and light activated (luminous intensity low/medium/high)	21/31/41
Line separator	Line voltage:	
	• Nominal	DC 32 V (= V_{nom})
	• Minimum	DC 12 V (= V_{min})
	• Maximum	DC 33 V (= V_{max})
	Voltage at which the line separator opens:	
	• Minimum	DC 7.5 V (= $V_{SO min}$)
	• Maximum	DC 10.5 V (= $V_{SO max}$)
	Permanent current when switches are closed	Max. 0.5 A (= $I_{C max}$)
	Switching current (e.g., in the event of a short-circuit)	Max. 1 A (= $I_{S max}$)
	Leakage current when switches are open	Max. 1 mA (= $I_{L max}$)
	Serial impedance when switches are closed:	
	• Point detector not used	0.5 Ω (= $Z_{C max}$)
	• Point detector used	2x 0.5 Ω

Function	Number of selectable tones	11	
	Number of programmable alarm levels	2	
	Number of programmable sound levels:	3	
	<ul style="list-style-type: none"> • 1 alarm sound level according to EN 54-3 • 2 test sound levels 		
	Adjustable maximum sound levels (typical values in dBA/m at DC 32 V with blanking plate BP720) For details, see 'Annex technical data'	82...89 dBA	
	Number of flashing modes	2	
	Number of programmable luminous intensity levels (not available with all control panels)	3	
	Adjustable maximum luminous intensity (typical values at DC 32 V with blanking plate BP720) For details, see 'Annex technical data'	0.70...3.8 cd	
	Ambient conditions	Operating temperature	-25...+55 °C
		Storage temperature	-30...+75 °C
	Air humidity	≤95 % rel.	
	Protection category (IEC 60529) with interbase seal RS721:		
	<ul style="list-style-type: none"> • When using the point detector • With blanking plate BP720 	IP21C IP21C	
	Electromagnetic compatibility at:		
	<ul style="list-style-type: none"> • 1 MHz...1 GHz • 1 GHz...2 GHz 	50 V/m 30 V/m	
Mechanical data	Dimensions (Ø x H)	127.4 x 51.6 mm	
	Weight DBS729	0.236 kg	
	Weight BP720	27 g	
	Material	Polycarbonate (PC)	
	Color:		
	<ul style="list-style-type: none"> • Outside • Body 	Translucent ~RAL 9010 pure white	
Standards	European standards	<ul style="list-style-type: none"> • EN 54-3, type A • EN 54-17 	

8.4 Dimensions

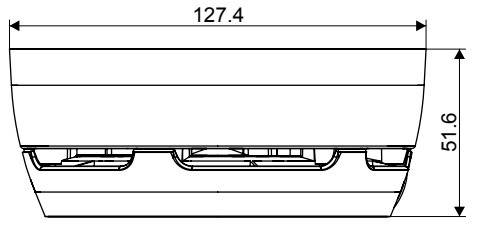
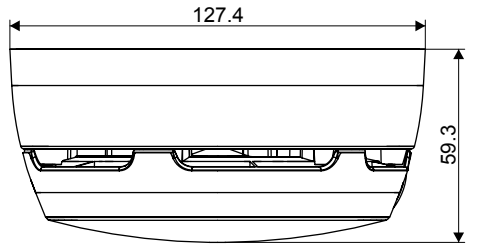
Interbase DBS72x	Interbase DBS72x with cover plate BP720
	

8.5 Environmental compatibility and disposal



This equipment is manufactured using materials and procedures which comply with current environmental protection standards as best as possible. More specifically, the following measures have been undertaken:

- Use of reusable materials
- Use of halogen-free plastics
- Electronic parts and synthetic materials can be separated

Larger plastic parts are labeled according to ISO 11469 and ISO 1043. The plastics can be separated and recycled on this basis.



Electronic parts and batteries must not be disposed of with domestic waste.

- Take electronic parts and batteries to local collection points or recycling centers.
- Contact local authorities for more information.
- Observe national requirements for disposing of electronic parts and batteries.

9 Annex technical data

9.1 Tones and sound levels of the interbase

To indicate the effective sound level of the DBS721 and DBS729 interbases, a polar coordinate system is used in accordance with EN 54-3, Annex A. The zero point ($0^\circ, 0^\circ$) refers to the position of the alarm indicator (AI) in an inserted point detector.

The direction of rotation from horizontal to vertical is counter-clockwise.

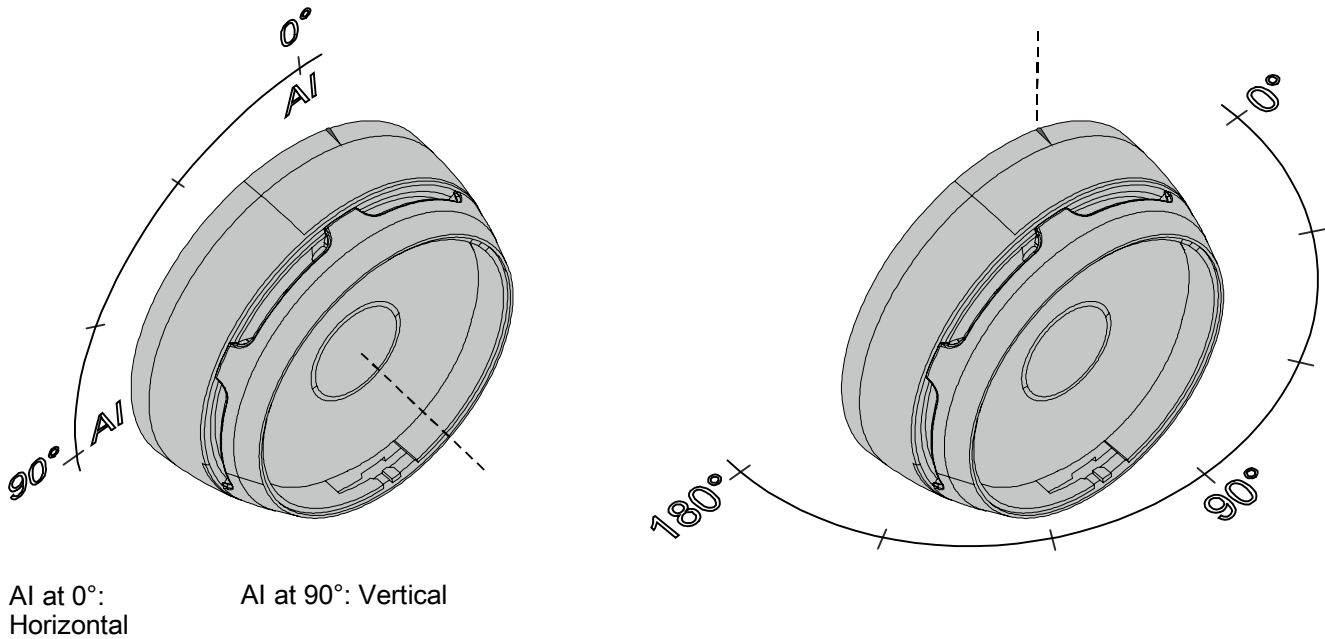

The measurements were performed with cover plate BP720 fitted.

9.1.1 DBS721 and DBS729 tones

The tables below illustrate the beam characteristics at maximum sound level. All of the sound levels specified are minimum values. For the tone no. 1 'Continuous', the sound levels are also specified at a reduced sound level for information purposes.

Sound level measured in dBA/1 m (DC 32 V)

Tone No. 1: Continuous

Sound level	Horizontal						Vertical					
	15°	45°	75°	105°	135°	165°	15°	45°	75°	105°	135°	165°
0 (max.)	77	72	84	84	72	74	78	72	84	82	71	77
1 (mid.)	66	62	74	73	61	64	68	62	74	72	60	67

Tone No. 2: Intermittent

Sound level	Horizontal						Vertical					
	15°	45°	75°	105°	135°	165°	15°	45°	75°	105°	135°	165°
0 (max.)	82	74	85	85	74	78	84	74	85	85	73	80

Tone No. 3: Sweep-down

Sound level	Horizontal						Vertical					
	15°	45°	75°	105°	135°	165°	15°	45°	75°	105°	135°	165°
0 (max.)	79	74	83	83	75	77	81	74	83	82	73	79

Tone No. 4: Slow-whoop Sweep-up, linear

Sound level	Horizontal						Vertical					
	15°	45°	75°	105°	135°	165°	15°	45°	75°	105°	135°	165°
0 (max.)	82	75	84	83	76	79	82	74	84	83	74	81

Tone No. 5: Pulse tone

Sound level	Horizontal						Vertical					
	15°	45°	75°	105°	135°	165°	15°	45°	75°	105°	135°	165°
0 (max.)	75	70	78	79	71	73	76	70	78	78	68	75

Tone No. 6: Intermittent

Sound level	Horizontal						Vertical					
	15°	45°	75°	105°	135°	165°	15°	45°	75°	105°	135°	165°
0 (max.)	74	69	78	78	71	73	75	70	78	77	68	74

Tone No. 7: Continuous

Sound level	Horizontal						Vertical					
	15°	45°	75°	105°	135°	165°	15°	45°	75°	105°	135°	165°
0 (max.)	76	71	79	79	72	74	76	71	79	79	69	76

Tone No. 8: Alternating

Sound level	Horizontal						Vertical					
	15°	45°	75°	105°	135°	165°	15°	45°	75°	105°	135°	165°
0 (max.)	78	71	79	80	72	75	78	70	80	80	69	77

Tone No. 9: Intermittent

Sound level	Horizontal						Vertical					
	15°	45°	75°	105°	135°	165°	15°	45°	75°	105°	135°	165°
0 (max.)	75	70	79	79	70	73	75	71	80	78	68	74

Tone No. 10: Slow-whoop Sweep-up, linear

Sound level	Horizontal						Vertical					
	15°	45°	75°	105°	135°	165°	15°	45°	75°	105°	135°	165°
0 (max.)	81	75	84	83	78	75	82	75	85	83	76	80

Tone No. 11: Intermittent

Sound level	Horizontal						Vertical					
	15°	45°	75°	105°	135°	165°	15°	45°	75°	105°	135°	165°
0 (max.)	77	72	84	84	71	74	78	69	84	82	72	78

9.1.2 DBS728 tones

The tables below illustrate the beam characteristics at maximum sound level. All of the sound levels specified are minimum values.

Minimum sound level measured in dBA/1 m

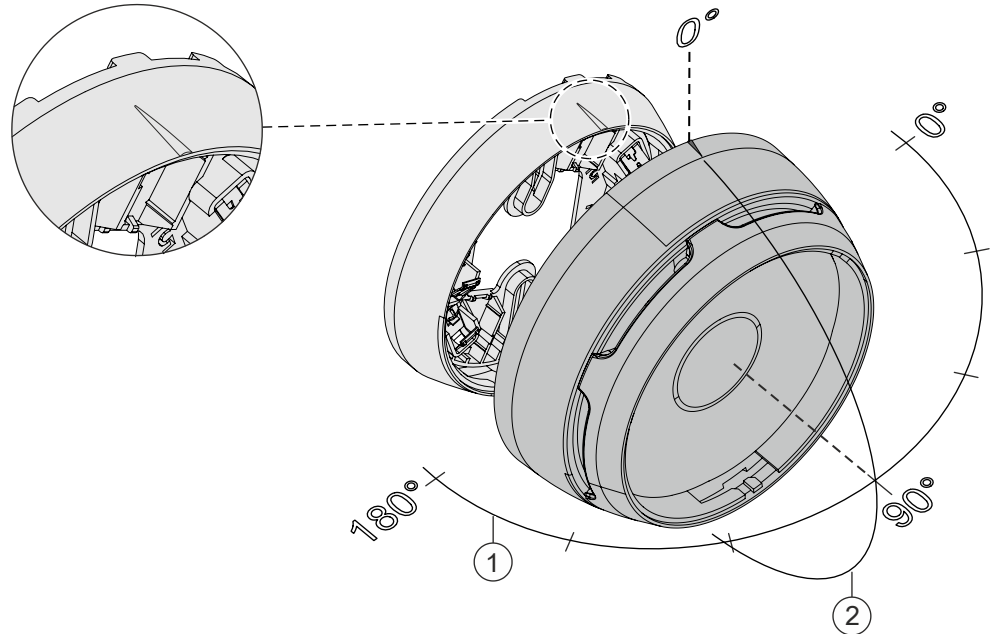

Figure 11: Measuring the sound level on interbase DBS728

1	Horizontal	2	Vertical
---	------------	---	----------



The marking on the detector base DB72x is used to align the interbase.

Tone No. 1: Continuous

Sound level	Horizontal						Vertical					
	15°	45°	75°	105°	135°	165°	15°	45°	75°	105°	135°	165°
0 (min.)	85.6	76.1	87.7	88.4	77.8	81.5	83.0	78.0	88.0	87.8	77.7	83.4

Tone No. 2: Intermittent

Sound level	Horizontal						Vertical					
	15°	45°	75°	105°	135°	165°	15°	45°	75°	105°	135°	165°
0 (min.)	84.4	77.2	88.5	88.5	77.9	82.2	82.3	79.6	88.6	87.9	79.6	84.0

Tone No. 3: Sweep-down

Sound level	Horizontal						Vertical					
	15°	45°	75°	105°	135°	165°	15°	45°	75°	105°	135°	165°
0 (min.)	85.4	82.0	90.6	89.9	82.5	84.8	83.5	82.0	90.5	89.9	82.7	84.2

Tone No. 4: Slow-whoop Sweep-up, linear

Sound level	Horizontal						Vertical					
	15°	45°	75°	105°	135°	165°	15°	45°	75°	105°	135°	165°
0 (min.)	86.5	83.9	91.7	91.5	84.2	86.7	84.6	83.5	91.8	91.4	83.9	85.4

Tone No. 5: Pulse tone

Sound level	Horizontal						Vertical					
	15°	45°	75°	105°	135°	165°	15°	45°	75°	105°	135°	165°
0 (min.)	81.6	76.0	86.3	85.9	76.6	81.9	79.2	75.3	86.4	86.1	76.7	80.7

Tone No. 6: Intermittent

Sound level	Horizontal						Vertical					
	15°	45°	75°	105°	135°	165°	15°	45°	75°	105°	135°	165°
0 (min.)	81.0	75.4	85.7	85.4	76.1	81.4	78.1	74.8	85.7	85.5	76.1	80.2

Tone No. 7: Continuous

Sound level	Horizontal						Vertical					
	15°	45°	75°	105°	135°	165°	15°	45°	75°	105°	135°	165°
0 (min.)	82.4	76.8	87.3	86.8	77.5	82.8	79.4	76.1	87.3	87.0	77.6	81.6

Tone No. 8: Alternating

Sound level	Horizontal						Vertical					
	15°	45°	75°	105°	135°	165°	15°	45°	75°	105°	135°	165°
0 (min.)	82.7	76.9	86.9	86.8	78.3	82.5	79.2	77.3	86.9	86.6	79.0	82.6

Tone No. 9: Intermittent

Sound level	Horizontal						Vertical					
	15°	45°	75°	105°	135°	165°	15°	45°	75°	105°	135°	165°
0 (min.)	81.0	76.9	85.1	84.5	77.9	80.3	78.5	77.2	84.8	84.6	77.7	80.2

Tone No. 10: Slow-whoop Sweep-up, linear

Sound level	Horizontal						Vertical					
	15°	45°	75°	105°	135°	165°	15°	45°	75°	105°	135°	165°
0 (min.)	86.9	83.7	91.8	92.6	84.1	86.9	81.4	83.3	92.2	91.8	84.5	85.8

Tone No. 11: Intermittent

Sound level	Horizontal						Vertical					
	15°	45°	75°	105°	135°	165°	15°	45°	75°	105°	135°	165°
0 (min.)	85.6	76.6	87.7	88.4	77.8	81.5	83.0	78.0	88.2	88.0	77.6	83.6

9.2 Optical beam characteristics of interbase DBS728 (DC 32 V)

The beam characteristics of the interbase DBS728 correspond to the EN 54-23 standard.

Class	Settings
C-3-5	Light/high
O-1.5-2.4	Dark/low (Ceiling-mounted with cylindrical cover cap as in Class C)

Beam characteristics according to EN 54-23

Graphic representation of beam characteristics C-x-y and O-x-y when an interbase DBS728 is ceiling-mounted.

Distances x and y in [m].

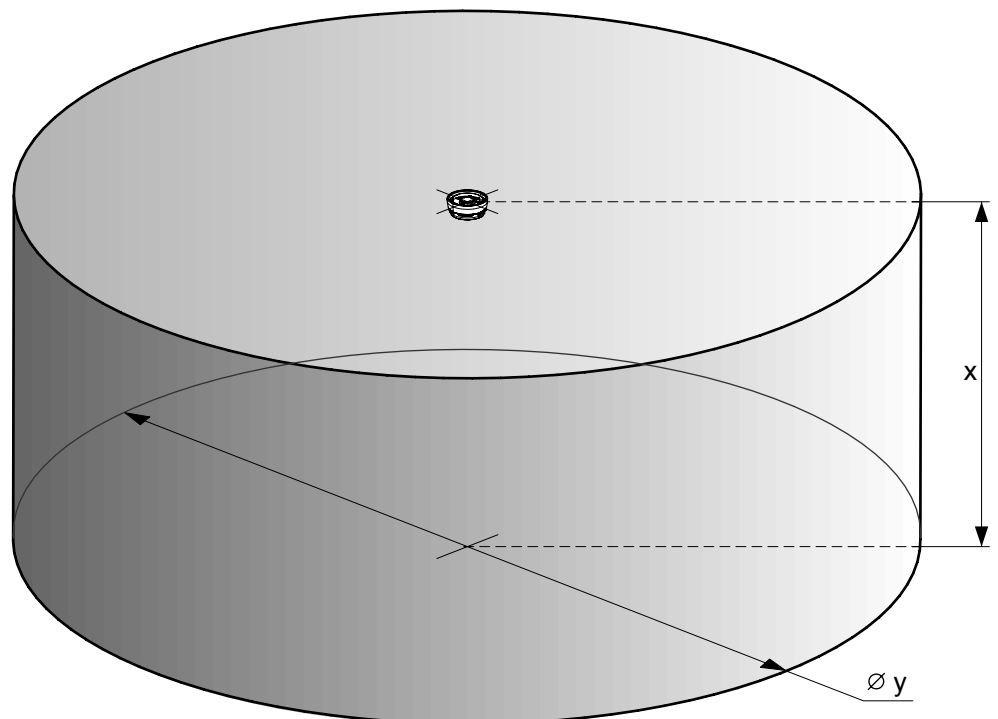

9.3 Optical beam characteristics of interbase DBS729 (DC 32 V)

To indicate the effective luminous intensity I_{eff} of the DBS729 interbase (in accordance with the Blondel-Rey law), a polar coordinate system is used based on azimuth and elevation. The zero point of the azimuth (0°) relates to the position of the internal alarm indicator in the interbase DBS729.

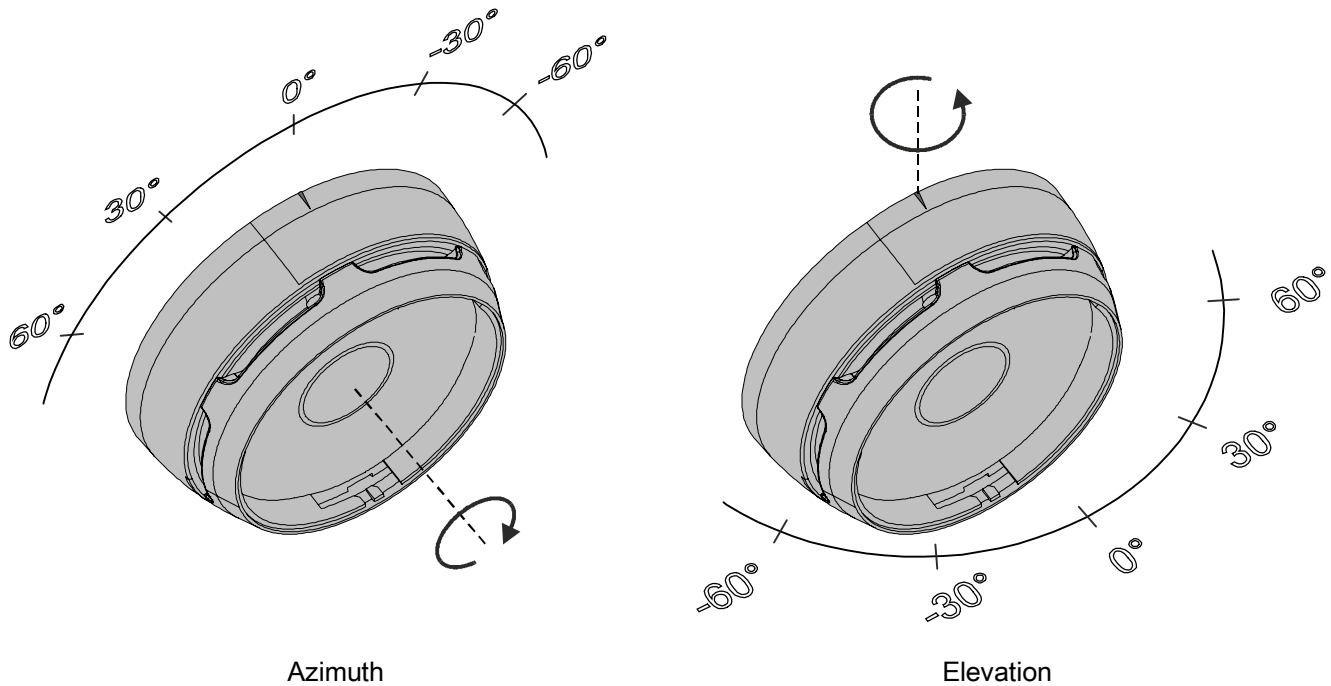

Effective luminous intensity of the DBS729 sounder interbase with supplementary optical indication with point detector inserted

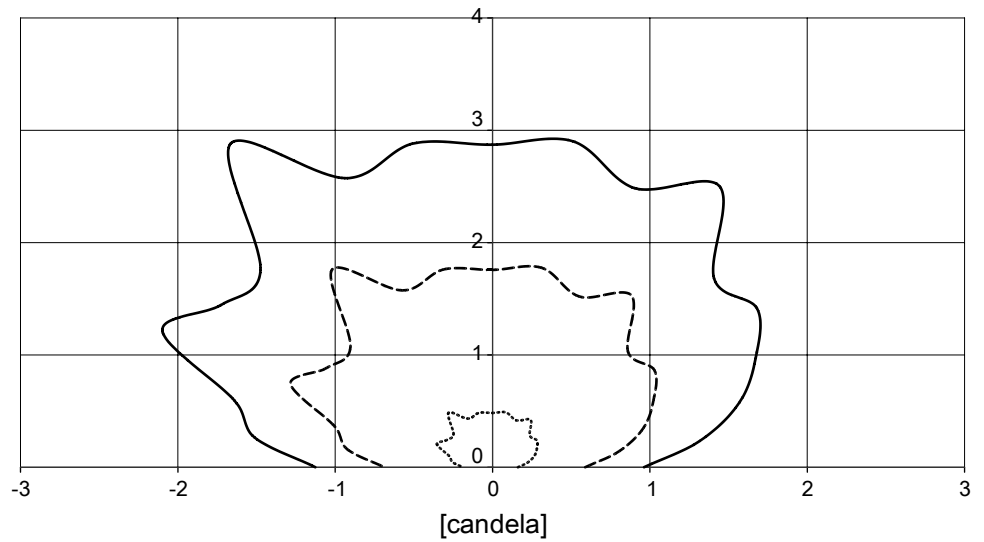

..... low intensity - - - - normal intensity — high intensity

Figure 12: Interbase DBS729 with point detector

Effective luminous intensity of the DBS729 sounder interbase with supplementary optical indication with cover plate BP720 fitted

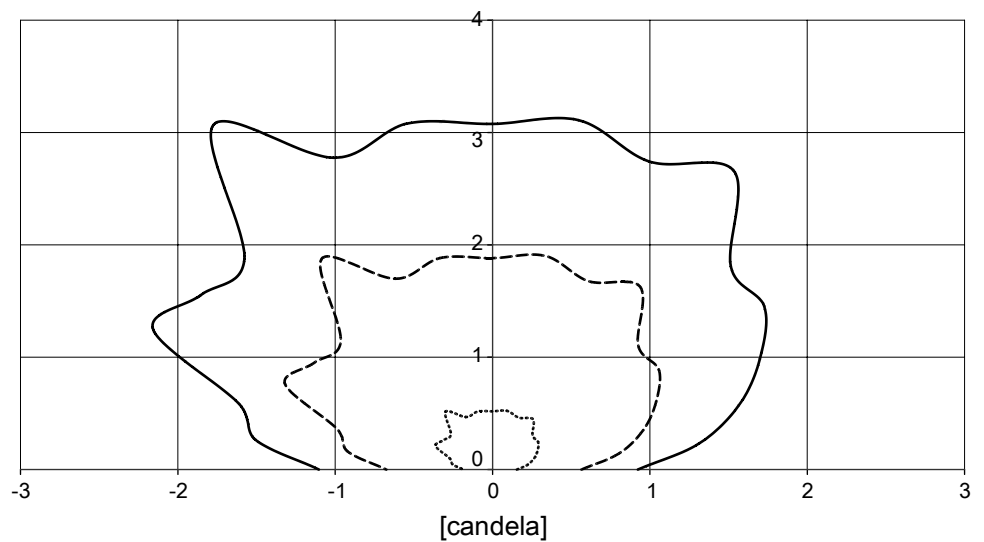

..... low intensity - - - - normal intensity — high intensity

Figure 13: Interbase DBS729 with cover plate BP720

Index

A	
Alarm level	15, 16, 17
Alarm levels	
Evacuation.....	19, 20
Warning.....	19, 20
Approvals.....	39, 41, 43
Azimuth	52
B	
Blondel-Rey	52
C	
CE marking	39, 41, 43
Compatibility.....	25
Control panel.....	37
D	
Degraded mode operation	
Fire control panel failure.....	21
Disposal.....	45
Documentation for fire detection system	7, 19
Download center	
URL.....	7
E	
Elevation.....	52
Environmental compatibility.....	45
ES	
Product version.....	18
EU directives	39, 41, 43
F	
Fire control panel failure	
Degraded mode operation	21
I	
Intended use	5
L	
LEDs	
Flashing frequency	20, 20
List of compatibility.....	7, 21, 25
Luminous intensity	16, 17, 44, 52
O	
Order number.....	18
Original language.....	6
P	
Packaging label	
Product version.....	18
Polar coordinate system	52
Product label	
Product version.....	18
R	
Recycling.....	45
S	
Seal label.....	22, 35
Service indicator	21
Sound level	19, 27, 30, 47, 49
Source language.....	6
Standards	40, 42, 44
Synchronization	
Limitations	26
T	
Tone.....	15, 16, 17, 47, 49
Type plate	
Product version.....	18



Issued by
Siemens Switzerland Ltd
Building Technologies Division
International Headquarters
Gubelstrasse 22
CH-6301 Zug
+41 41-724 24 24
www.siemens.com/buildingtechnologies

© Siemens Switzerland Ltd, 2011
Technical specifications and availability subject to change without notice.